

MEMORANDO No.497-RRHH-2022

PARA LIC. JONYS AGUILERA
OFICIAL DE TRANSPARENCIA/OIP

DE LINDA MARIA ORDÓÑEZ
DIRECTORA DE RECURSOS HUMANOS

ASUNTO LO DESCRITO

FECHA 21 DE OCTUBRE DE 2022



En seguimiento al Memorando-Cenid-No.186-2022 correspondiente al mes de **SEPTIEMBRE** 2022 se remite información para actualizar el portal de transparencia.

- Planilla Mensual de Sueldos por Acuerdo (Gastos de Representación, Vacaciones)
- Planilla de CENAOS Permanente y Jornal
- Circulares dirigidas a todo el personal
- Planillas generadas por programas de emergencia (dengue)
- Contrataciones SEPTIEMBRE enviadas al correo

Sin otro Particular,

Atentamente.

COMISION PERMANENTE DE CONTINGENCIAS

COPECO

PLANILLA DE SUELDOS CORRESPONDIENTES AL MES DE SEPTIEMBRE 2022

No	CARGO	SUELDO DEVENGADO	NETO A PAGAR	GASTOS DE REPRESENTACION	VACACIONES
1	de Gestion de Riesgos y Contingencias Nacionales	90,000.00	68,036.27	20,000.00	
2	Asistente del Comisionado Nacional	35,000.00	30,009.37		
3	Asesor en el Area Administrativa y Financiera	55,000.00	44,366.15		
4	Asesor Tecnico en Normas Procesos y Procedimientos Institucionales	43,000.00	35,992.88		
5	Enlace de Regionales	30,000.00	26,051.45		
6	Sub-Secretario de Estado en los Despachos de Gestion de Riesgos y Contingencias Nacionales	60,000.00	46,978.62	15,000.00	
8	Secretario General	50,000.00	42,871.45		
9	Sub-Comisionado Nor-Occidental (Regional No.1,2 y 3.)	55,000.00	45,649.45		
10	Jefe de la Unidad de Modernizacion	20,000.00	18,041.45		
12	Asistente de la Unidad de Planificacion Evaluacion de la Gestion	14,300.00	12,825.95		
13	Director de la Unidad de Cooperacion Internacional y Relaciones Institucional	45,000.00	21,456.73		
14	Secretaria de Cooperacion Internacional	11,200.00	9,989.45		
15	Director de Riesgos Ambientales	43,000.00	37,296.69		
16	Jefe de la Unidad Forestal	25,000.00	17,796.07		
17	Asistente Tecnico	20,000.00	18,041.45		
18	Auxiliar de Auditoria	18,000.00	16,211.45		
19	Director de Gestion de la Prevencion	43,000.00	30,299.37		28,666.66
20	Asistente de la Direccion de Gestion de la Prevencion	13,300.00	11,820.95		
21	Jefe de Mantenimiento	15,000.00	13,466.45		
22	Director de Tecnologias de la Informacion y Comunicacion	43,000.00	37,083.19		
23	Jefe del Departamento de Infotecnologia	18,000.00	8,783.30		
24	Tecnico en Radiocomunicaciones	14,000.00	8,130.07		9,333.33
25	Jefe del Departamento de Comunicaciones	15,000.00	13,466.45		
26	Director Administrativa y Financiera	51,400.00	41,765.24		
27	Jefe de Estadistica y Censos	22,000.00	19,871.45		
28	Jefe de Contabilidad	22,000.00	19,567.17		
29	Auxiliar de Compras	17,000.00	15,296.45		
30	Enlace Administrativo	23,000.00	20,786.45		
31	Auxiliar Administrativo	13,100.00	11,302.74		
32	Secretaria	10,320.00	6,039.07		
33	Oficial de Bienes Nacionales	11,000.00	9,806.45		
34	Encargado de Proveeduria	10,320.00	3,108.79		
35	Jefe de Servicios Generales	23,000.00	19,744.24		
36	Motorista del Comisionado Nacional	18,000.00	16,211.45		
37	Asistente Administrativo	16,800.00	15,113.45		
38	Auxiliar Administrativo	13,000.00	10,836.45		
39	Motorista del Sub Comisionado	12,000.00	10,721.45		
40	Motorista	12,000.00	5,251.98		
41	Motorista	12,000.00	6,186.36		

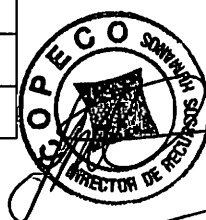

COMISION PERMANENTE DE CONTINGENCIAS

COPECO

PLANILLA DE SUELDOS CORRESPONDIENTES AL MES DE SEPTIEMBRE 2022

No	CARGO	SUELDO DEVENGADO	NETO A PAGAR	GASTOS DE REPRESENTACION	VACACIONES
42	Motorista	10,320.00	6,069.39		
43	Motorista	3,096.00	2,574.29		
44	Motorista	10,320.00	6,831.10		
45	Motorista	10,320.00	9,184.25		
46	Motorista	10,320.00	9,184.25		
47	Aseadora	10,320.00	3,467.64		
48	Aseadora	10,320.00	7,555.25		
49	Aseador	10,320.00	5,025.50		
50	Aseador	10,320.00	3,732.43		
51	Aseadora	10,320.00	3,438.71		
52	Aseadora	10,320.00	9,184.25		
53	Auxiliar de Mantenimiento	10,320.00	5,256.73		
54	Electricista	13,200.00	11,819.45		
55	Pintor	17,250.00	14,816.51		
56	Director de Recursos Humanos	50,390.00	39,974.86		
57	Jefe de SIARH	39,200.00	26,942.34		
58	Recepcionista	13,820.00	12,386.75		
59	Asistente de Recursos Humanos	17,000.00	13,397.90		
60	Axiliar de Recursos Humanos	16,520.00	14,857.25		
61	Asistente	27,500.00	24,903.95		
62	Secretaria	10,320.00	9,184.25		
63	Director del centro nacional de investigacion y capacitacion para la atencion de contingencias(CENICAC)	43,000.00	34,544.83		
64	Encargado de Capacitacion	17,000.00	15,296.45		
65	Jefe de la Unidad de Organización Institucional	17,000.00	15,296.45		
66	Jefe de la Unidad de Organización Comunitaria	12,500.00	5,555.88		
67	Oficial Tecnico de Formacion en Riesgo	12,000.00	10,721.45		
68	Oficial de Investigacion en Gestion de Riesgos	10,320.00	9,184.25		
69	Oficial de CENICAC	16,000.00	10,533.90		
70	Encargado del CENID-GDR	20,000.00	13,934.71		
71	Gestor de Informacion	10,320.00	9,184.25		
72	Secretaria	10,800.00	6,654.51		
73	Director de Comunicación Social	50,000.00	40,973.87		
74	Jefe del Departamento Ceremonial y Protocolo	23,275.00	16,137.12		
75	Asistente de Prensa	14,000.00	8,082.74		
76	Asistente de Prensa	13,800.00	12,368.45		
77	Asistente de Prensa	10,320.00	9,184.25		
78	Director de preparacion y Respuesta	50,000.00	40,973.87		
79	Asistente de Preparacion y Respuesta	17,500.00	11,109.36		
80	Asistente de Preparacion y Respuesta	17,000.00	15,296.45		
81	Secretaria de Dirección de Preparacion y Respuesta	19,000.00	8,166.08		12,666.66



COMISION PERMANENTE DE CONTINGENCIAS

COPECO

PLANILLA DE SUELDOS CORRESPONDIENTES AL MES DE SEPTIEMBRE 2022

No	CARGO	SUELDO DEVENGADO	NETO A PAGAR	GASTOS DE REPRESENTACION	VACACIONES
82	Jefe del Departamento de Sistemas de Alerta Temprana	17,000.00	3,120.76		
83	Meteorologo	26,000.00	17,678.34		
84	Asesor Tecnico	22,000.00	19,871.45		
85	Asistente del Departamento de Operaciones	10,320.00	6,464.40		6,880.00
86	Sub Jefe de Operaciones	15,000.00	7,275.00		
87	Jefe de COEN	35,000.00	31,766.45		
88	Jefe de Manejo de Informacion	16,000.00	1,976.81		
89	Encargado de Monitoreo	10,320.00	3,414.34		
90	Encargado de Monitoreo	10,320.00	4,553.17		
91	Encargado de Monitoreo	10,320.00	6,404.18		6,880.00
92	Encargado de Monitoreo	10,320.00	9,184.25		
93	Jefe del Departamento de Asistencia Humanitaria	35,000.00	31,766.45		
94	Asistente de Logistica	10,320.00	9,184.25		
95	Secretaria	18,000.00	10,094.84		
96	Oficial de Logistica	11,000.00	7,495.72		
97	Oficial de Logistica	10,320.00	3,342.73		
98	Motorista	10,320.00	3,757.61		
99	Ayudante de Bodega	10,320.00	4,556.25		
100	Ayudante de Bodega	10,320.00	5,069.11		
101	Oficial de Asistencia Humanitaria	10,320.00	9,184.25		
102	Oficial de Respuesta Inmediata	10,320.00	2,757.19		
103	Oficial de Respuesta Inmediata	10,320.00	4,895.85		
104	Oficial de Logistica	17,250.00	3,651.18		
105	Asistente Administrativo	23,500.00	16,240.55		
106	Auxiliar Administrativo	21,040.00	18,993.05		
107	Sub-Comisionado Regional	27,500.00	24,272.30		
108	Sub - Comisionado Departamental de Atlantida	23,000.00	14,625.94		15,333.33
109	Asistente Administrativo	15,320.00	9,181.28		
110	Asistente Tecnico	10,320.00	3,263.80		
111	Oficial de Asistencia Humanitaria	15,320.00	10,769.77		
112	Aseadora	10,320.00	9,184.25		
113	Sub- Comisionado de la Oficina Departamental de Islas de la Bahía	18,000.00	16,211.45		
115	Sub Comisionado Departamental de Colon	14,950.00	13,420.70		
116	Sub-Comisionado Regional	27,500.00	23,614.23		
117	Asistente de Comunicación Social y Protocolo	17,250.00	13,492.45		
119	Ayudante de Bodega Regional	10,320.00	3,051.59		
120	Encargado de Monitoreo Regional	15,000.00	13,466.45		
121	Oficial de Asistencia Social Regional	10,320.00	9,184.25		
122	Sub-Comisionado de la oficina regional N.3	30,000.00	26,941.20		



COMISION PERMANENTE DE CONTINGENCIAS

COPECO

PLANILLA DE SUELDOS CORRESPONDIENTES AL MES DE SEPTIEMBRE 2022

No	CARGO	SUELDO DEVENGADO	NETO A PAGAR	GASTOS DE REPRESENTACION	VACACIONES
123	Oficial de Asistencia Social Regional	11,000.00	9,806.45		
125	Oficial de Logística Regional	10,320.00	9,184.25		
126	Oficial de Asistencia Humanitaria Regional	10,320.00	7,631.90		
127	Motorista Regional	12,000.00	10,721.45		
128	Sub-Comisionado Departamental de Copan	13,500.00	12,093.95		
129	Sub-Comisionado Regional	20,000.00	18,041.45		
130	Asistente Administrativo	10,320.00	9,184.25		
131	Sub-Comisionado Regional	23,000.00	20,786.45		
133	Oficial de Asistencia Social Regional	10,320.00	7,543.98		
135	Enlace Administrativo	23,400.00	21,152.45		
136	Sub-Comisionado Regional	23,400.00	21,152.45		
137	Asistente Administrativo	18,000.00	16,211.45		
138	Oficial de Logística Regional	12,220.00	10,922.75		
139	Sub-Comisionado Regional	30,000.00	26,629.69		
140	Auxiliar de la Regional N.7	10,320.00	7,110.37		
141	Sub-Comisionado de la Departamental De El Paraíso	15,000.00	13,466.45		
TOTAL		2,657,581.00	2,034,277.34	35,000.00	79,759.98

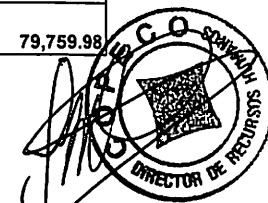

COMISION PERMANENTE DE CONTINGENCIAS (COPECO)

PLANILLA DE EMPLEADOS POR ACUERDO DE SUELDOS DEL MES DE SEPTIEMBRE 2022

No.	PUESTO	SUELDO	NETO A PAGAR
1	SECRETARIA	10,320.00	9,184.25
2	SECRETARIA	17,000.00	13,296.45
3	ASISTENTE ADMINISTRATIVO	21,000.00	12,472.77
4	ASISTENTE DEL DIRECTOR DE COOPERACION INTERNACIONAL	18,000.00	16,211.45
5	JEFE DE AUDITORIA INTERNA	40,000.00	32,458.71
6	SECRETARIA	12,320.00	9,018.38
7	ASISTENTE ADMINISTRATIVO	15,000.00	13,466.45
8	OFICIAL DE PREVENCION	16,000.00	14,381.45
9	OFICIAL DE PREVENCION	16,000.00	14,381.45
10	OFICIAL DE PREVENCION	16,000.00	8,375.25
11	SUB COMISIONADO REGIONAL CENTRO SUR	43,000.00	39,086.45
12	SUPERVISOR DE PROYECTOS SOCIALES	21,000.00	18,956.45
13	ASESOR DE PROYECTOS	43,000.00	34,544.93
14	SUPERVISOR DE PROYECTOS SOCIALES	18,000.00	16,211.45
15	OFICIAL DE PROYECTOS	10,320.00	7,984.25
16	ASEADOR	10,820.00	6,047.67
17	OFICIAL DE MANTENIMIENTO	10,320.00	7,146.82
18	OFICIAL DE MANTENIMIENTO	11,820.00	10,556.75
19	AUXILIAR DE BIENES NACIONALES	13,000.00	11,636.45
20	AUXILIAR ADMINISTRATIVO	10,320.00	9,184.25
21	AUXILIAR DE TRANSPORTE	11,820.00	10,556.75
22	AUXILIAR ADMINISTRATIVO	10,320.00	5,740.16
23	AUXILIAR ADMINISTRATIVO	10,320.00	9,184.25
24	MOTORISTA	10,320.00	2,971.64
25	MECANICO	10,320.00	5,046.12
26	MECANICO	10,320.00	9,184.25
27	ENLACE ADMINISTRATIVO	22,360.00	19,837.28
28	PINTOR	12,000.00	5,329.87
29	MOTORISTA	10,320.00	9,184.25
30	MOTORISTA	11,000.00	4,773.95
31	CONSERJE	10,320.00	
32	ASEADOR	10,820.00	

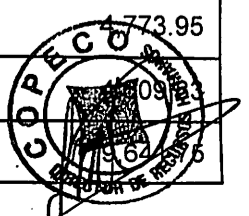

COMISION PERMANENTE DE CONTINGENCIAS (COPECO)

PLANILLA DE EMPLEADOS POR ACUERDO DE SUELDOS DEL MES DE SEPTIEMBRE 2022

No.	PUESTO	SUELDO	NETO A PAGAR
33	ASEADOR	10,820.00	3,101.86
34	ASEADOR	11,820.00	7,534.62
35	ASEADOR	10,820.00	4,451.37
36	ASEADOR	10,820.00	2,897.41
37	ASEADOR	10,820.00	4,316.95
38	ASEADOR	10,820.00	4,625.93
39	ENCARGADO DE BIENES NACIONALES	25,000.00	22,616.45
40	OFICIAL DE BIENES NACIONALES	17,000.00	15,296.45
41	AUXILIAR DE BIENES NACIONALES	10,320.00	9,184.25
42	OFICIAL DE MANTENIMIENTO	10,320.00	8,212.25
43	TECNICO EN PROGRAMACION	15,000.00	12,757.45
44	AUXILIAR DE BIENES NACIONALES	20,000.00	16,547.45
45	TECNICO AUXILIAR DE CONTROL INTERNO	10,320.00	9,184.25
46	TECNICO JEFE EN GESTION DE PROYECTOS	20,000.00	18,041.45
47	AUDITOR DE COMPRAS	30,000.00	25,504.63
48	JEFE DE COMPRAS	28,000.00	24,068.97
49	OFICIAL DE RECURSOS HUMANOS	11,820.00	10,556.75
50	AUXILIAR DE AUDITORIA	17,000.00	15,296.45
51	AUXILIAR JURIDICO	20,000.00	18,041.45
52	DISEÑADOR GRAFICO Y WED MASTER	18,000.00	13,197.45
53	AUXILIAR DE RELACIONES PUBLICAS	15,000.00	5,448.75
54	AUXILIAR DE PROTOCOLO	15,000.00	13,466.45
55	AUXILIAR DE PROTOCOLO	15,000.00	13,466.45
56	AUXILIAR DE PROTOCOLO	15,000.00	8,035.88
57	AUXILIAR DE PRENSA	15,000.00	13,466.45
58	DIRECTOR DE CENTRO DE ESTUDIOS ADMOFERICOS, OCEANOGRAFICOS Y	43,000.00	20,939.19
59	HIDROLOGO	23,000.00	20,317.47
60	ASISTENTE EJECUTIVO Y ADMINISTRATIVO	35,000.00	28,231.69
61	OFICIAL DE MONITOREO	10,320.00	4,215.49
62	COORDINADOR DE CLIMATOLOGIA Y CAMBIO CLIMATICO	16,000.00	38,445
63	OFICIAL DE UNIDAD DE RESPUESTA INMEDIATA	10,320.00	6,298.46
64	OFICIAL DE UNIDAD DE RESPUESTA INMEDIATA	15,000.00	13,466.45

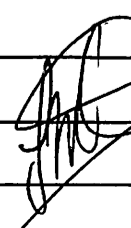
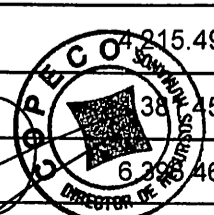
COMISION PERMANENTE DE CONTINGENCIAS (COPECO)

PLANILLA DE EMPLEADOS POR ACUERDO DE SUELDOS DEL MES DE SEPTIEMBRE 2022

No.	PUESTO	SUELDO	NETO A PAGAR
65	ENLACE DEL SISTEMA NACIONAL DE EMERGENCIA 911	22,000.00	12,602.63
66	ENLACE DE DIRECCION DE EMERGENCIA SANITARIA	25,540.00	23,110.55
67	OFICIAL DE RECURSOS HUMANOS	20,820.00	18,111.75
68	OFICIAL DE LOGISTICA	15,820.00	14,216.75
69	AUXILIAR DE TECNOLOGIA Y COMUNICACIÓN	11,040.00	9,843.05
70	OFICIAL DE AYUDA HUMANITARIA	10,320.00	5,129.25
71	OFICIAL DE AYUDA HUMANITARIA	10,320.00	2,320.60
72	OFICIAL DE ASISTENCIA HUMANITARIA	20,000.00	18,041.45
73	MOTORISTA	12,000.00	4,662.34
74	OFICIAL DE OPERACIONES	12,820.00	5,871.32
75	OFICIAL DE AYUDA HUMANITARIA	10,500.00	9,348.95
76	MOTORISTA	11,500.00	5,938.58
77	ENCARGADO DE COMBUSTIBLE	20,000.00	18,041.45
78	ASISTENTE ADMINISTRATIVO	25,000.00	19,798.22
79	ASISTENTE EJECUTIVO	51,040.00	40,135.98
80	MOTORISTA	18,000.00	10,263.30
81	AUXILIAR DE LOGISTICA	18,000.00	14,902.45
82	ANALISTA DE RECURSOS HUMANOS	35,000.00	25,695.69
83	ENLACE ADMINISTRATIVO	25,000.00	21,818.07
84	ENLACES DE REGIONALES	25,000.00	21,818.07
85	ENLACES DE REGIONALES	20,000.00	17,254.45
86	ENLACES DE REGIONALES	20,000.00	18,041.45
87	ENLACES DE REGIONALES	20,000.00	18,041.45
88	AUXILIAR ADMINISTRATIVO	25,000.00	21,818.07
89	ASESOR DE DESARROLLO PSICOSOCIAL	50,000.00	39,412.75
90	ENLACE ADMINISTRATIVO	25,000.00	12,000.40
91	COORDINADOR DE ENLACES DE REGIONALES	25,000.00	21,818.07
92	JEFE DE TRANSPORTE	22,360.00	10,837.28
93	AUXILIAR ADMINISTRATIVO	30,000.00	22,900.64
94	ASESOR LEGAL	25,000.00	21,818.07
95	ASESOR LEGAL	25,000.00	21,818.07
96	SECRETARIA	25,000.00	22,616.45

DIRECTOR DE RECURSOS



COMISION PERMANENTE DE CONTINGENCIAS (COPECO)

PLANILLA DE EMPLEADOS POR ACUERDO DE SUELDOS DEL MES DE SEPTIEMBRE 2022

No.	PUESTO	SUELDO	NETO A PAGAR
97	JEFE DE LA UNIDAD DE SISMOLOGIA	23,000.00	15,343.45
98	APODERADO LEGAL	35,000.00	31,766.45
99	JEFE DE BODEGA	32,000.00	28,534.83
100	SUB DIRECTOR DE PREPARACION Y RESPUESTA	20,000.00	18,041.45
101	OFICIAL DE PREVENCION Y GESTION DE RIESGO	25,000.00	21,818.07
102	OFICIAL DE PREVENCION Y GESTION DE RIESGO	25,000.00	22,616.45
103	OFICIAL DE PREVENCION Y GESTION DE RIESGO	25,000.00	21,818.07
104	OFICIAL DE PREVENCION Y GESTION DE RIESGO	25,000.00	21,818.07
105	ASESOR LEGAL	43,000.00	34,544.93
106	DIRECTOR DE LA DE UNIDAD MEDICA DE EMERGENCIA	43,000.00	34,544.93
107	CORDINADOR DE UNIDAD MEDICA DE EMERGENCIA	40,000.00	5,219.45
108	OFICIAL PRE-HOSPITALARIO	16,000.00	14,381.45
109	OFICIAL PRE-HOSPITALARIO	16,000.00	4,033.45
110	OFICIAL PRE-HOSPITALARIO	16,000.00	14,381.45
111	OFICIAL PRE-HOSPITALARIO	16,000.00	14,381.45
112	OFICIAL PRE-HOSPITALARIO	16,000.00	14,381.45
113	OFICIAL PRE-HOSPITALARIO	18,000.00	13,017.00
114	OFICIAL PRE-HOSPITALARIO	16,000.00	14,381.45
115	OFICIAL PRE-HOSPITALARIO	16,000.00	14,381.45
116	OFICIAL PRE-HOSPITALARIO	16,000.00	14,381.45
117	OFICIAL PRE-HOSPITALARIO	16,000.00	4,133.45
118	OFICIAL PRE-HOSPITALARIO	16,000.00	14,381.45
119	SUB DIRECTOR DE UNIDAD MEDICA DE EMERGENCIA	24,000.00	21,067.77
120	OFICIAL PRE-HOSPITALARIO	16,000.00	14,381.45
121	OFICIAL PRE-HOSPITALARIO	16,000.00	8,524.78
122	AUXILIAR PRE HOSPITALARIO	12,000.00	4,721.45
123	AUXILIAR PRE HOSPITALARIO	12,000.00	5,732.44
124	AUXILIAR PRE HOSPITALARIO	12,000.00	6,777.89
125	AUXILIAR PRE HOSPITALARIO	12,000.00	5,041.02
126	AUXILIAR PRE HOSPITALARIO	12,000.00	5,041.02
127	AUXILIAR PRE HOSPITALARIO	12,000.00	5,041.02
128	AUXILIAR PRE HOSPITALARIO	12,000.00	10,721.45



COMISION PERMANENTE DE CONTINGENCIAS (COPECO)



PLANILLA DE EMPLEADOS POR ACUERDO DE SUELDOS DEL MES DE SEPTIEMBRE 2022

No.	PUESTO	SUELDO	NETO A PAGAR
129	AUXILIAR PRE HOSPITALARIO	12,000.00	10,721.45
130	AUXILIAR PRE HOSPITALARIO	12,000.00	10,721.45
131	AUXILIAR PRE HOSPITALARIO	12,000.00	6,804.60
132	AUXILIAR PRE HOSPITALARIO	12,000.00	6,462.53
133	AUXILIAR PRE HOSPITALARIO	12,000.00	7,131.44
134	AUXILIAR PRE HOSPITALARIO	12,000.00	10,721.45
135	AUXILIAR PRE HOSPITALARIO	12,000.00	10,721.45
136	AUXILIAR PRE HOSPITALARIO	12,000.00	10,721.45
137	AUXILIAR PRE HOSPITALARIO	12,000.00	10,721.45
138	AUXILIAR PRE HOSPITALARIO	12,000.00	7,665.45
139	AUXILIAR PRE HOSPITALARIO	12,000.00	10,721.45
140	AUXILIAR PRE HOSPITALARIO	12,000.00	10,721.45
141	AUXILIAR PRE HOSPITALARIO	12,000.00	7,139.97
142	AUXILIAR PRE HOSPITALARIO	12,000.00	9,571.45
143	AUXILIAR PRE HOSPITALARIO	12,000.00	10,721.45
144	AUXILIAR PRE HOSPITALARIO	12,000.00	10,721.45
145	AUXILIAR PRE HOSPITALARIO	12,000.00	10,721.45
146	AUXILIAR PRE HOSPITALARIO	12,000.00	10,721.45
147	AUXILIAR PRE HOSPITALARIO	12,000.00	3,004.68
148	AUXILIAR PRE HOSPITALARIO	12,000.00	10,721.45
149	AUXILIAR PRE HOSPITALARIO	12,000.00	10,721.45
150	AUXILIAR PRE HOSPITALARIO	12,000.00	10,721.45
151	AUXILIAR PRE HOSPITALARIO	12,000.00	7,581.98
152	JEFE DE OPERACIONES DE LA UNIDAD MEDICA DE EMERGENCIA	40,000.00	32,458.71
153	SECRETARIA	15,000.00	13,466.45
154	MOTORISTA	11,040.00	9,843.05
155	AUXILIAR PRE HOSPITALARIO	12,000.00	2,169.30
156	MOTORISTA	11,040.00	9,843.05
157	MOTORISTA	11,040.00	9,843.05
158	MOTORISTA	11,040.00	9,843.05
159	MOTORISTA	11,040.00	9,843.05
160	MOTORISTA	11,040.00	9,843.05

COMISION PERMANENTE DE CONTINGENCIAS (COPECO)

PLANILLA DE EMPLEADOS POR ACUERDO DE SUELDOS DEL MES DE SEPTIEMBRE 2022

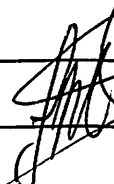
No.	PUESTO	SUELDO	NETO A PAGAR
161	MOTORISTA	11,040.00	6,242.76
162	MOTORISTA	11,040.00	5,021.48
163	MOTORISTA	11,040.00	9,843.05
164	MOTORISTA	11,960.00	5,039.16
165	MOTORISTA	11,040.00	6,059.52
166	MOTORISTA	11,040.00	9,417.05
167	MOTORISTA	11,040.00	9,843.05
168	MOTORISTA	11,040.00	9,418.05
169	MOTORISTA	11,040.00	9,843.05
170	MOTORISTA	11,040.00	9,843.05
171	MOTORISTA	11,040.00	5,105.16
172	MOTORISTA	11,040.00	6,169.13
173	MOTORISTA	11,040.00	5,300.48
174	MOTORISTA	11,040.00	7,807.93
175	MOTORISTA	11,040.00	9,643.05
176	MOTORISTA	11,040.00	6,267.98
177	MOTORISTA	11,040.00	9,343.05
178	MOTORISTA	11,040.00	4,898.91
179	MOTORISTA	11,040.00	6,046.36
180	MOTORISTA	11,040.00	4,044.01
181	MOTORISTA	11,040.00	9,843.05
182	MOTORISTA	11,040.00	5,639.04
183	MOTORISTA	11,040.00	8,942.05
184	MOTORISTA	11,040.00	9,843.05
185	MOTORISTA	11,040.00	7,950.05
186	MOTORISTA	11,040.00	5,448.05
187	MOTORISTA	11,040.00	6,262.34
188	MOTORISTA	11,040.00	5,186.05
189	MOTORISTA	11,040.00	5,121.05
190	MOTORISTA	11,040.00	3,475.16
191	MOTORISTA	11,040.00	9,843.05
192	MOTORISTA	11,040.00	6,097.36

COMISION PERMANENTE DE CONTINGENCIAS (COPECO)

PLANILLA DE EMPLEADOS POR ACUERDO DE SUELDOS DEL MES DE SEPTIEMBRE 2022

No.	PUESTO	SUELDO	NETO A PAGAR
193	MOTORISTA	11,040.00	9,093.05
194	MOTORISTA	11,040.00	5,038.11
195	MOTORISTA	11,040.00	5,005.16
196	MOTORISTA	11,040.00	6,558.05
197	MOTORISTA	11,040.00	6,716.05
198	MOTORISTA	11,040.00	9,843.05
199	MOTORISTA	11,040.00	9,843.05
200	MOTORISTA	11,040.00	9,843.05
201	MOTORISTA	11,040.00	9,843.05
202	MOTORISTA	11,040.00	9,843.05
203	ENLACE DE RECURSOS HUMANOS	30,320.00	18,507.11
204	AUXILIAR ADMINISTRATIVO	13,500.00	3,447.20
205	AUXILIAR ADMINISTRATIVO	13,500.00	10,035.20
206	ENLACE ADMINISTRATIVO	20,000.00	17,241.45
207	JEFE DE LOGISTICA	17,500.00	1,167.15
208	JEFE DE LOGISTICA	15,000.00	13,466.45
209	ASISTENTE ADMINISTRATIVO	14,000.00	8,142.55
210	SECRETARIA	11,040.00	4,696.16
211	AUXILIAR DE LOGISTICA	11,040.00	9,843.05
212	AUXILIAR DE LOGISTICA	11,040.00	4,899.40
213	AUXILIAR DE LOGISTICA	11,040.00	5,851.07
214	AUXILIAR DE LOGISTICA	11,040.00	5,449.41
215	AUXILIAR DE LOGISTICA	11,040.00	4,238.58
216	AUXILIAR DE LOGISTICA	11,040.00	3,876.13
217	AUXILIAR DE LOGISTICA	11,040.00	9,843.05
218	DESPACHADOR	11,040.00	6,713.09
219	DESPACHADOR	12,040.00	7,006.75
220	AUXILIAR ADMINISTRATIVO	12,000.00	12,211.45
221	ENLACE DE REGIONALES	14,000.00	12,211.45
222	JEFE DE MANTENIMIENTO	15,000.00	13,266.45
223	AUXILIAR DE MANTENIMIENTO	11,040.00	1,909.06
224	OFICIAL DE LA UNIDAD DE RESPUESTA INMEDIATA	11,040.00	5,048.91

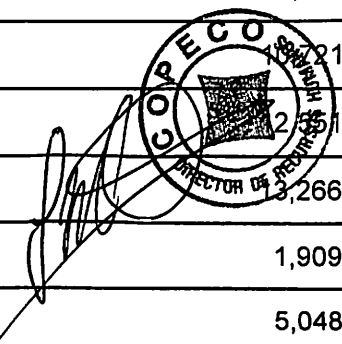

COPECO
DIRECTOR DE CONTINGENCIAS

COMISION PERMANENTE DE CONTINGENCIAS (COPECO)

PLANILLA DE EMPLEADOS POR ACUERDO DE SUELDOS DEL MES DE SEPTIEMBRE 2022

No.	PUESTO	SUELDO	NETO A PAGAR
225	OFICIAL DE LA UNIDAD DE RESPUESTA INMEDIATA	11,040.00	6,631.14
226	OFICIAL DE LA UNIDAD DE RESPUESTA INMEDIATA	11,040.00	8,343.05
227	OFICIAL DE LA UNIDAD DE RESPUESTA INMEDIATA	11,040.00	9,843.05
228	OFICIAL DE LA UNIDAD DE RESPUESTA INMEDIATA	11,040.00	9,843.05
229	OFICIAL DE LA UNIDAD DE RESPUESTA INMEDIATA	12,040.00	10,758.05
230	OFICIAL DE LA UNIDAD DE RESPUESTA INMEDIATA	15,000.00	9,393.25
231	JEFE DE UNIDAD DE RESPUESTA INMEDIATA	20,000.00	18,041.45
232	OFICIAL DE LA UNIDAD DE RESPUESTA INMEDIATA	11,040.00	8,043.05
233	OFICIAL DE LA UNIDAD DE RESPUESTA INMEDIATA	11,040.00	9,843.05
234	ASEADOR	11,040.00	8,392.05
235	CORDINADOR DE UNIDAD MEDICA DE EMERGENCIA	28,000.00	24,068.97
236	AUXILIAR PRE HOSPITALARIO	12,000.00	9,435.45
237	AUXILIAR PRE HOSPITALARIO	12,000.00	10,108.45
238	AUXILIAR PRE HOSPITALARIO	12,000.00	10,721.45
239	AUXILIAR PRE HOSPITALARIO	12,000.00	10,721.45
240	AUXILIAR PRE HOSPITALARIO	12,000.00	7,952.45
241	AUXILIAR PRE HOSPITALARIO	12,000.00	10,721.45
242	AUXILIAR PRE HOSPITALARIO	12,000.00	9,270.45
243	AUXILIAR PRE HOSPITALARIO	12,000.00	10,721.45
244	AUXILIAR PRE HOSPITALARIO	12,000.00	10,721.45
245	AUXILIAR PRE HOSPITALARIO	12,000.00	10,721.45
246	AUXILIAR PRE HOSPITALARIO	12,000.00	10,721.45
247	AUXILIAR PRE HOSPITALARIO	12,000.00	7,170.22
248	AUXILIAR PRE HOSPITALARIO	12,000.00	7,086.09
249	AUXILIAR PRE HOSPITALARIO	12,000.00	10,121.45
250	AUXILIAR PRE HOSPITALARIO	12,000.00	10,721.45
251	AUXILIAR PRE HOSPITALARIO	12,000.00	10,721.45
252	AUXILIAR PRE HOSPITALARIO	12,000.00	10,721.45
253	AUXILIAR PRE HOSPITALARIO	12,000.00	10,721.45
254	AUXILIAR PRE HOSPITALARIO	12,000.00	10,721.45
255	AUXILIAR PRE HOSPITALARIO	12,000.00	10,721.45
256	AUXILIAR PRE HOSPITALARIO	12,000.00	10,721.45

COMISION PERMANENTE DE CONTINGENCIAS (COPECO)

PLANILLA DE EMPLEADOS POR ACUERDO DE SUELDOS DEL MES DE SEPTIEMBRE 2022

No.	PUESTO	SUELDO	NETO A PAGAR
257	AUXILIAR PRE HOSPITALARIO	12,000.00	10,346.45
258	AUXILIAR PRE HOSPITALARIO	12,000.00	8,337.45
259	AUXILIAR PRE HOSPITALARIO	12,000.00	10,721.45
260	AUXILIAR PRE HOSPITALARIO	12,000.00	10,721.45
261	AUXILIAR PRE HOSPITALARIO	12,000.00	10,721.45
262	AUXILIAR PRE HOSPITALARIO	12,000.00	10,721.45
263	AUXILIAR PRE HOSPITALARIO	12,000.00	10,721.45
264	AUXILIAR PRE HOSPITALARIO	12,000.00	10,721.45
265	AUXILIAR PRE HOSPITALARIO	12,000.00	10,721.45
266	AUXILIAR PRE HOSPITALARIO	12,000.00	10,721.45
267	AUXILIAR PRE HOSPITALARIO	12,000.00	7,521.45
268	AUXILIAR PRE HOSPITALARIO	12,000.00	5,289.45
269	AUXILIAR PRE HOSPITALARIO	12,000.00	10,721.45
270	AUXILIAR PRE HOSPITALARIO	12,000.00	10,721.45
271	AUXILIAR PRE HOSPITALARIO	12,000.00	10,721.45
272	AUXILIAR PRE HOSPITALARIO	12,000.00	10,721.45
273	AUXILIAR PRE HOSPITALARIO	12,000.00	10,721.45
274	AUXILIAR PRE HOSPITALARIO	12,000.00	10,721.45
275	AUXILIAR PRE HOSPITALARIO	12,000.00	10,721.45
276	AUXILIAR PRE HOSPITALARIO	12,000.00	10,721.45
277	JEFE DE OPERACIONES DE LA UNIDAD MEDICA DE EMERGENCIA	28,000.00	24,268.97
278	MOTORISTA	11,040.00	7,501.81
279	MOTORISTA	11,040.00	9,843.05
280	MOTORISTA	11,040.00	9,843.05
281	MOTORISTA	11,040.00	9,843.05
282	MOTORISTA	11,040.00	8,959.05
283	MOTORISTA	11,040.00	9,218.05
284	MOTORISTA	11,040.00	9,843.05
285	MOTORISTA	11,040.00	9,843.05
286	MOTORISTA	11,040.00	9,843.05
287	MOTORISTA	11,040.00	9,843.05
288	MOTORISTA	11,040.00	5,948.05

Director de COPECO

COMISION PERMANENTE DE CONTINGENCIAS (COPECO)

PLANILLA DE EMPLEADOS POR ACUERDO DE SUELDOS DEL MES DE SEPTIEMBRE 2022

No.	PUESTO	SUELDO	NETO A PAGAR
289	MOTORISTA	11,040.00	9,843.05
290	MOTORISTA	11,040.00	9,843.05
291	MOTORISTA	11,040.00	9,843.05
292	MOTORISTA	11,040.00	9,843.05
293	MOTORISTA	11,040.00	9,843.05
294	MOTORISTA	11,040.00	9,843.05
295	MOTORISTA	11,040.00	9,843.05
296	MOTORISTA	11,040.00	9,843.05
297	MOTORISTA	11,040.00	9,843.05
298	MOTORISTA	11,040.00	9,843.05
299	MOTORISTA	11,040.00	9,843.05
300	MOTORISTA	11,040.00	9,843.05
301	MOTORISTA	11,040.00	9,843.05
302	MOTORISTA	11,040.00	9,843.05
303	MOTORISTA	11,040.00	9,843.05
304	MOTORISTA	11,040.00	9,843.05
305	MOTORISTA	11,040.00	9,843.05
306	MOTORISTA	11,040.00	9,843.05
307	MOTORISTA	11,040.00	9,843.05
308	MOTORISTA	11,040.00	9,843.05
309	MOTORISTA	11,040.00	9,643.05
310	MOTORISTA	11,040.00	9,843.05
311	MOTORISTA	11,040.00	9,843.05
312	MOTORISTA	11,040.00	9,843.05
313	MOTORISTA	11,040.00	9,843.05
314	MOTORISTA	11,040.00	8,796.05
315	MOTORISTA	11,040.00	8,737.05
316	AUXILIAR PRE HOSPITALARIO	12,000.00	10,145.05
317	MOTORISTA	11,040.00	9,843.05
318	MOTORISTA	11,040.00	9,843.05
319	MOTORISTA	11,040.00	9,843.05
320	MOTORISTA	11,040.00	9,843.05

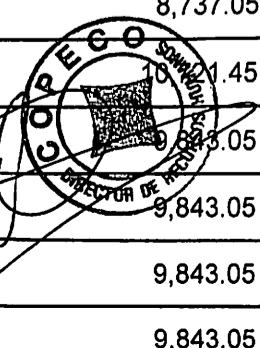

COMISION PERMANENTE DE CONTINGENCIAS (COPECO)

PLANILLA DE EMPLEADOS POR ACUERDO DE SUELDOS DEL MES DE SEPTIEMBRE 2022

No.	PUESTO	SUELDO	NETO A PAGAR
321	MOTORISTA	11,040.00	9,843.05
322	MOTORISTA	11,040.00	9,105.05
323	MOTORISTA	11,040.00	9,843.05
324	MOTORISTA	11,040.00	9,843.05
325	MOTORISTA	11,040.00	9,843.05
326	AUXILIAR ADMINISTRATIVO	20,000.00	18,041.45
327	AUXILIAR DE LOGISTICA	15,000.00	13,466.45
328	AUXILIAR DE LOGISTICA	15,000.00	13,466.45
329	DESPACHADOR	12,000.00	10,721.45
330	DESPACHADOR	12,000.00	10,721.45
331	DESPACHADOR	12,000.00	10,721.45
332	DESPACHADOR	12,000.00	10,721.45
333	DESPACHADOR	12,000.00	10,721.45
334	AUXILIAR DE MANTENIMIENTO	11,040.00	7,119.05
335	AUXILIAR DE MANTENIMIENTO	11,040.00	9,843.05
336	OFICIAL DE LA UNIDAD DE RESPUESTA INMEDIATA	11,040.00	9,843.05
337	OFICIAL DE LA UNIDAD DE RESPUESTA INMEDIATA	11,040.00	7,517.05
338	OFICIAL DE LA UNIDAD DE RESPUESTA INMEDIATA	11,040.00	9,843.05
339	OFICIAL DE LA UNIDAD DE RESPUESTA INMEDIATA	11,040.00	7,443.05
340	OFICIAL DE LA UNIDAD DE RESPUESTA INMEDIATA	11,040.00	8,514.05
341	OFICIAL DE LA UNIDAD DE RESPUESTA INMEDIATA	11,040.00	9,843.05
342	OFICIAL DE LA UNIDAD DE RESPUESTA INMEDIATA	11,040.00	9,843.05
343	OFICIAL DE LA UNIDAD DE RESPUESTA INMEDIATA	11,040.00	9,843.05
344	OFICIAL DE LA UNIDAD DE RESPUESTA INMEDIATA	11,040.00	9,843.05
345	BODEGUEROS	12,000.00	7,209.45
346	BODEGUEROS	12,000.00	10,721.45
347	BODEGUEROS	12,000.00	10,721.45
348	MECANICO	11,040.00	9,843.05
349	CORDINADOR DE UNIDAD MEDICA DE EMERGENCIA	18,000.00	16,721.45
350	AUXILIAR PRE HOSPITALARIO	12,000.00	10,721.45
351	AUXILIAR PRE HOSPITALARIO	12,000.00	10,721.45
352	AUXILIAR PRE HOSPITALARIO	12,000.00	10,721.45



COMISION PERMANENTE DE CONTINGENCIAS (COPECO)

PLANILLA DE EMPLEADOS POR ACUERDO DE SUELDOS DEL MES DE SEPTIEMBRE 2022

No.	PUESTO	SUELDO	NETO A PAGAR
353	AUXILIAR PRE HOSPITALARIO	12,000.00	10,721.45
354	AUXILIAR PRE HOSPITALARIO	12,000.00	10,721.45
355	AUXILIAR PRE HOSPITALARIO	12,000.00	6,547.41
356	AUXILIAR PRE HOSPITALARIO	12,000.00	10,721.45
357	MOTORISTA	11,040.00	9,843.05
358	MOTORISTA	11,040.00	7,548.01
359	MOTORISTA	11,040.00	9,843.05
360	MOTORISTA	11,040.00	9,843.05
361	MOTORISTA	11,040.00	9,843.05
362	AUXILIAR ADMINISTRATIVO	16,000.00	14,381.45
363	AUXILIAR ADMINISTRATIVO	12,000.00	10,721.45
364	AUXILIAR PRE HOSPITALARIO	12,000.00	10,721.45
365	AUXILIAR PRE HOSPITALARIO	12,000.00	10,721.45
366	MOTORISTA	11,040.00	9,843.05
367	MOTORISTA	11,040.00	9,843.05
368	AUXILIAR PRE HOSPITALARIO	12,000.00	5,407.60
369	AUXILIAR PRE HOSPITALARIO	12,000.00	7,291.67
370	AUXILIAR PRE HOSPITALARIO	12,000.00	10,721.45
371	MOTORISTA	11,040.00	9,843.05
372	AUXILIAR PRE HOSPITALARIO	12,000.00	10,721.45
373	AUXILIAR PRE HOSPITALARIO	12,000.00	10,721.45
374	AUXILIAR PRE HOSPITALARIO	12,000.00	10,721.45
375	MOTORISTA	11,040.00	9,843.05
376	MOTORISTA	11,040.00	9,843.05
377	MOTORISTA	11,040.00	9,843.05
378	AUXILIAR PRE HOSPITALARIO	12,000.00	10,721.45
379	AUXILIAR PRE HOSPITALARIO	12,000.00	10,721.45
380	AUXILIAR PRE HOSPITALARIO	12,000.00	10,721.45
381	MOTORISTA	11,040.00	9,843.05
382	MOTORISTA	11,040.00	9,843.05
383	AUXILIAR PRE HOSPITALARIO	12,000.00	7,914.45
384	AUXILIAR PRE HOSPITALARIO	12,000.00	10,721.45

COPECO
DIRECTOR

COMISION PERMANENTE DE CONTINGENCIAS (COPECO)

PLANILLA DE EMPLEADOS POR ACUERDO DE SUELDOS DEL MES DE SEPTIEMBRE 2022

No.	PUESTO	SUELDO	NETO A PAGAR
385	MOTORISTA	11,040.00	3,490.80
386	AUXILIAR PRE HOSPITALARIO	12,000.00	10,721.45
387	AUXILIAR PRE HOSPITALARIO	12,000.00	10,721.45
388	MOTORISTA	11,040.00	9,843.05
389	AUXILIAR PRE HOSPITALARIO	12,000.00	10,721.45
390	AUXILIAR PRE HOSPITALARIO	12,000.00	10,721.45
391	AUXILIAR PRE HOSPITALARIO	12,000.00	10,721.45
392	MOTORISTA	11,040.00	9,843.05
393	MOTORISTA	11,040.00	9,843.05
394	MOTORISTA	11,040.00	9,843.05
395	MOTORISTA	11,040.00	9,843.05
396	MOTORISTA	11,040.00	9,843.05
397	MOTORISTA	11,040.00	9,843.05
398	AUXILIAR PRE HOSPITALARIO	12,000.00	10,721.45
399	AUXILIAR PRE HOSPITALARIO	12,000.00	10,721.45
400	AUXILIAR PRE HOSPITALARIO	12,000.00	10,721.45
401	MOTORISTA	11,040.00	6,364.25
402	MOTORISTA	11,040.00	9,843.05
403	MOTORISTA	11,040.00	9,843.05
404	AUXILIAR PRE HOSPITALARIO	12,000.00	10,721.45
405	AUXILIAR PRE HOSPITALARIO	12,000.00	10,721.45
406	AUXILIAR PRE HOSPITALARIO	12,000.00	10,721.45
407	AUXILIAR PRE HOSPITALARIO	12,000.00	10,721.45
408	MOTORISTA	11,040.00	9,843.05
409	MOTORISTA	11,040.00	9,843.05
410	MOTORISTA	11,040.00	9,843.05
411	MOTORISTA	11,040.00	9,843.05
412	AUXILIAR PRE HOSPITALARIO	12,000.00	10,721.45
413	AUXILIAR PRE HOSPITALARIO	12,000.00	10,721.45
414	AUXILIAR PRE HOSPITALARIO	12,000.00	10,721.45
415	AUXILIAR PRE HOSPITALARIO	12,000.00	10,721.45
416	AUXILIAR PRE HOSPITALARIO	12,000.00	10,721.45

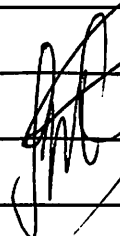
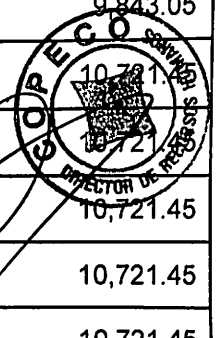
COMISION PERMANENTE DE CONTINGENCIAS (COPECO)

PLANILLA DE EMPLEADOS POR ACUERDO DE SUELDOS DEL MES DE SEPTIEMBRE 2022

No.	PUESTO	SUELDO	NETO A PAGAR
417	AUXILIAR PRE HOSPITALARIO	12,000.00	10,721.45
418	MOTORISTA	11,040.00	9,843.05
419	MOTORISTA	11,040.00	9,843.05
420	MOTORISTA	11,040.00	9,843.05
421	AUXILIAR PRE HOSPITALARIO	12,000.00	10,721.45
422	AUXILIAR PRE HOSPITALARIO	12,000.00	10,721.45
423	MOTORISTA	11,040.00	9,843.05
424	MOTORISTA	11,040.00	9,843.05
425	MOTORISTA	11,040.00	9,843.05
426	AUXILIAR PRE HOSPITALARIO	12,000.00	10,721.45
427	AUXILIAR PRE HOSPITALARIO	12,000.00	10,721.45
428	AUXILIAR PRE HOSPITALARIO	12,000.00	10,721.45
429	MOTORISTA	11,040.00	9,843.05
430	MOTORISTA	11,040.00	9,843.05
431	MOTORISTA	11,040.00	9,843.05
432	AUXILIAR PRE HOSPITALARIO	12,000.00	10,721.45
433	AUXILIAR PRE HOSPITALARIO	12,000.00	10,721.45
434	MOTORISTA	11,040.00	9,843.05
435	MOTORISTA	11,040.00	9,843.05
436	AUXILIAR PRE HOSPITALARIO	12,000.00	10,721.45
437	AUXILIAR PRE HOSPITALARIO	12,000.00	10,721.45
438	MOTORISTA	11,040.00	9,843.05
439	AUXILIAR DE TIC	10,320.00	9,184.25
440	PROGRAMADOR	20,000.00	18,041.45
441	OFICIAL DE INFORMATICA	11,000.00	9,806.45
442	TECNICO EN ELECTRONICA	13,000.00	9,098.70
443	AUXILIAR DE TIC	10,320.00	9,184.25
444	SUB- COMISIONADO DEPARTAMENTAL DE YORO	22,000.00	19,507.88
445	ORGANIZACIÓN DE CODELES REGIONAL D.C	18,000.00	16,287.145
446	OFICIAL TECNICO	15,000.00	13,466.45
447	AYUDANTE DE BODEGA DEPARTAMENTAL DE COLON	10,320.00	9,184.25
448	ENLACE DE RECURSOS HUMANOS	20,000.00	16,584.45

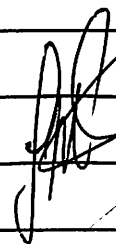
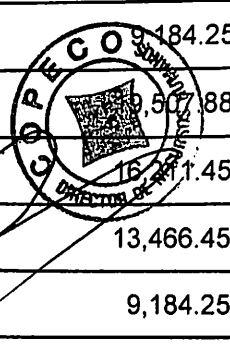

COMISION PERMANENTE DE CONTINGENCIAS (COPECO)

PLANILLA DE EMPLEADOS POR ACUERDO DE SUELDOS DEL MES DE SEPTIEMBRE 2022

No.	PUESTO	SUELDO	NETO A PAGAR
449	JEFE DE OPERACIONES NOR OCCIDENTAL	25,000.00	21,818.07
450	JEFE DE BODEGA	25,000.00	21,268.07
451	ASEADOR	10,350.00	9,211.70
452	ASISTENTE ADMINISTRATIVO	12,000.00	10,721.45
453	SECRETARIA	10,320.00	9,184.25
454	ASEADOR	10,340.00	9,202.55
455	AUXILIAR JURIDICO	20,000.00	18,041.45
456	SUB COMISIONADO	13,000.00	11,636.45
457	SUB COMISIONADO	16,000.00	14,381.45
458	OFICIAL DE LOGISTICA	10,320.00	9,184.25
459	ASEADOR	10,350.00	9,211.70
460	OFICIAL DE AYUDA HUMANITARIA	10,320.00	8,121.55
461	AYUDANTE DE BODEGA	10,320.00	9,184.25
462	OFICINISTA	10,320.00	9,184.25
463	ASEADOR	10,320.00	9,184.25
464	OFICIAL DE MANTENIMIENTO	10,320.00	9,184.25
465	ASISTENTE VOLUNTARIADO	25,000.00	21,818.07
466	OFICIAL DE PREVENCION DEPARTAMENTAL DE VALLE	14,000.00	12,551.45
467	SUB COMISIONADO	30,000.00	25,434.37
468	OFICIAL DE AYUDA HUMANITARIA	13,000.00	11,636.45
469	OFICIAL TECNICO REGIONAL	10,320.00	6,178.52
		53,320.00	43,249.34
	TOTAL	6,567,880.00	5,213,980.26

Elaborado por: Hancy Lanza
 Oficial de Recursos Humanos
 COPECO